

# CHEST UNIT

wren

## Feature Open Chest & Storage Unit Fitting Guide

### FEATURE CHEST 1 - FI.PK.BED.222.016

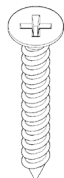

**(K) x8**  
30mm  
Screw

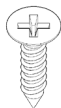

**(L) x18**  
15mm  
Screw

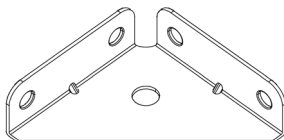

**2x** Corner Gusset Plate



**Screws and fixings for attaching to walls and chest tops are not provided as these vary depending on materials, thickness and construction. Ensure appropriate fixings are used.**

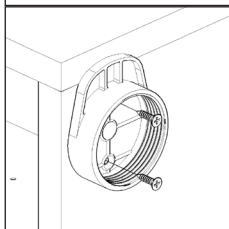

#### **Step1.**

Place the unit on its side. Secure each of the legs in place with 2 x 15mm screws **(L)** per leg. Ensure legs are rotated as shown so the tab is supporting the end panel. Attach bottom section of legs and set all legs to the same height.

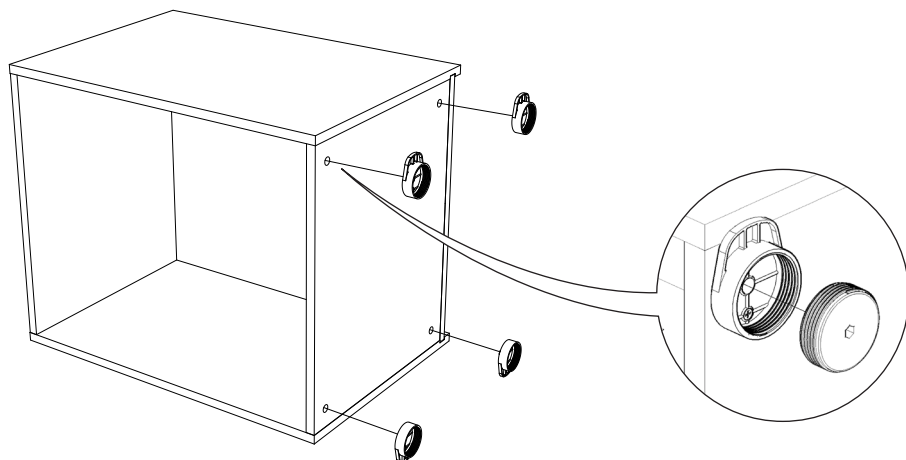

# CHEST UNIT

**wren**

## Feature Open Chest & Storage Unit Fitting Guide

### FEATURE CHEST 1 - FI.PK.BED.222.016

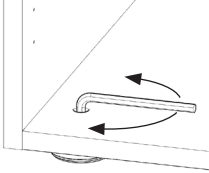
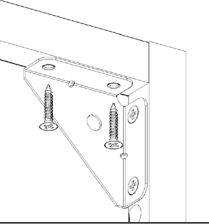
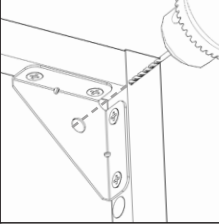
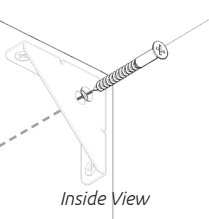
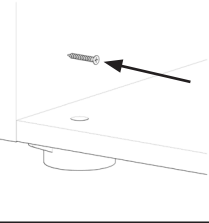
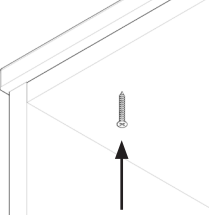
	<p><b>Step 2.</b> Position the unit and level using an 8mm hex key from inside the unit.</p>	
	<p><b>Step 3.</b> Secure corner gusset plates to the top left and right side on the back of the unit, using 4 x 15mm screws (<b>L</b>) per plate. Drill a pilot hole through the centre of the corner gusset plate.</p>	
 <p><i>Inside View</i></p>	<p><b>Step 4.</b> Secure the unit to the wall by screwing through the pilot hole and gusset from <b>step 3</b> into the wall.</p>	
	<p><b>Step 5.</b> Screw into any side units using the 30mm screws (<b>K</b>) provided to secure to the unit. Screw at the top and bottom on both sides of the unit.</p>	
	<p><b>Step 6.</b> Screw up through the top fixed shelf into the chest top using 30mm screws (<b>K</b>) provided to secure it in place.</p>	